



1.6L Soup Maker User's Manual

Please visit www.drewandcole.com for video instructions and cooking demonstrations.

by

drew & cole[®]

Index

Topic

Important safeguards	03
Box contents	10
Features	11
Control panel	12
Before using your Soup Maker	13
Setting up your Soup Maker	14
Preparation	15
Making soup	16
LED display	17
Serving your soup	18
Using the smooth+ function	19
Using the auto clean function	20
Cleaning & maintenance	21
Troubleshooting	22

Important Safeguards

When using electrical appliances, basic safety precautions should always be followed including the following:

IMPORTANT SAFEGUARDS SAFETY INSTRUCTIONS

Read these instructions for use carefully before using your appliance for the first time and keep them to hand for future reference.

This user's manual is also available in PDF format, please contact the Customer Services Team if you wish to have one.

If you require any more information, assistance or spares, please contact our Customer Services Team - their opening hours are as follows:

8:00am - 7:30pm (Monday - Friday)

8:00am - 1:00pm (Saturdays and Sunday)

You can contact them

between these hours on:

0344 800 0631 (UK customers)

0412 132 998 (Irish customers)

Alternatively you can send them an email on CustomerCare@highstreettv.com

- This appliance is for household use only.
- The appliance may be used by persons with reduced physical, sensory or mental capabilities, or lack of experience or knowledge, if they have been given supervision or instruction concerning the use of the appliance. Children must be supervised to ensure they do not play with the appliance or any parts of the appliance or the packaging.

Important Safeguards (cont...)

- This appliance shall not be used by children. Keep the appliance and its cord out of reach of children.
- Do not use the appliance for any other than the intended use, described by this booklet. Any other use, especially misuse, can cause severe injuries or damage by electric shock, heat or fire.
- Do not leave the appliance unattended, when it is connected to the power supply.
- Ensure that the appliance is switched off before removing it from its stand.
- Always disconnect the appliance from the supply if it is left unattended and before assembling, disassembling or cleaning.
- Any operation, repair and technical maintenance of the appliance or any part of it (e.g. exchanging any permanently mounted parts) other than described in the instructions may only be performed at an authorised service centre. Please contact the Customer Service Team.
- If the supply cord is damaged, it must be replaced by the manufacturer, its service agent or similarly qualified persons in order to avoid hazard.
- This appliance is intended to be used in household and similar applications such as: farm houses, by clients in hotels, motels and other residential type environments, bed and breakfast type environments. It is not

Important Safeguards (cont...)

suitable for use in staff kitchen areas in shops, offices and other working environments.

- This appliance is not intended for commercial use
- **WARNING:** The mixing blades are very sharp. Handle with care when using and cleaning. See page 18 for more information on how to clean your appliance.
- This appliance is not intended to be operated by means of an external timer or separate remote control systems.

GENERAL SAFETY INSTRUCTIONS

- Do not operate or store the appliance in humid or wet areas or outdoors.
- This appliance is NOT intended for use in boats or moving vehicles.
- Do not use any accessories, attachments or spare parts not recommended by the manufacturer. Damaged or unsuited parts could cause cracks, distortions or leakage of hot water.
- Do not operate the appliance when the appliance or any part of it is likely to be damaged to avoid risk of fire, overflow, heat, electric shock or any other damage and/or injuries to persons.
- Check the appliance regularly for any leakage. However, due to condensation, small amounts of moisture on the base may occur. This is normal. Regularly check the power cord for proper operation.
- The pins of the plug must be smooth and clean without any

Important Safeguards (cont...)

discolouration.

- Do not operate the appliance when any part of it is likely to be damaged or is not working properly.
- Return the appliance to an authorised service centre for examination and repair, if the appliance is not operating properly or overheating, or was subject to inadmissible strain (e.g. overheating, mechanical or electric shock, moisture in the electrical connectors). Unplug the appliance immediately, when a severe problem occurs during operation (e.g. water over flowing, overheating). Do not attempt to open or repair the appliance on your own.
- Operate the appliance on a well accessible, heat resistant, water resistant, stable, level, dry and suitable large table or counter. Do not place the appliance on inclined surfaces, where it can tilt or fall. Ensure that the appliance is stable before using the it.
- During operation keep the appliance in an appropriate distance of at least 20 cm of free space on each side.
- Do not place any clothes or tissues or other objects under or on the appliance during operation, to avoid risk of fire, electric shock and overheating. Do not place the appliance near the edge of the table or counter.
- Do not place the appliance or any part of it on or near hot surfaces (e.g. burner, heater, range or oven). The

Important Safeguards (cont...)

appliance is heated by built-in electric heating elements. Do not place any part of the appliance on a hot oven or range.

- Always unplug the appliance when it is not in use, and before moving or cleaning the appliance.
- Always leave the appliance to cool down before cleaning.
- Always ensure that the appliance is filled correctly and the exterior and the electric connectors are dry and clean before use.
- Do not overfill the appliance. Always observe the MAX filling mark in the interior of the appliance.
- There is no warranty claim of the purchaser, if the damaged or defect of the appliance is caused by inappropriate treatment.
- Do not use abrasive cleaners or cleaning pads for cleaning the appliance or any part of it. **DO NOT** clean the appliance with any chemicals (e.g. bleach).
- Do not use any hard or sharp-edged objects for operation or cleaning.
- Always use extreme caution when moving an appliance when it contains hot contents.
- Never remove the lid until the blades have stopped.
- Do not use the appliance to continuously make batches of soup. After using the appliance, allow it to cool thoroughly then clean before using it again.
- **DO NOT place the appliance or power cord in an automatic dishwasher.**

Important Safeguards (cont...)

IMPORTANT SAFEGUARDS FOR ELECTRICAL APPLIANCES

- Carefully read all instructions before operating the appliance and save for future reference.
- Place the appliance near a suitable wall power socket and connect the appliance directly to a protected mains power supply with protective conductor (earth/ground) connected properly. For this, always unwind the power cord completely. Do not use any extension cord or multi-socket outlet adaptor.
- Ensure that the voltage rating of your mains power supply corresponds to the voltage requirements of the appliance (220-240V, 50/60Hz, AC, rated for at least 13A).
- The power cord must not be knotted, twisted, pulled, strained or squeezed.
- Ensure the power cord is not strained or over tight when plugged into the mains socket.
- Do not let the plug or power cord hang over the edge of the table or counter. Ensure that no one will pull the appliance by the power cord or entangle in the power cord.
- Always grasp the plug to disconnect the power cord.
- Do not touch the power plug or appliance with wet hands while the appliance is connected to the mains power supply.
- Always unplug the appliance before moving or cleaning. Do not leave the appliance unattended when it is connected to

Important Safeguards (cont...)

- the power supply.
 - The power cord may not touch hot surfaces or sharp edges.
 - Do not place the appliance on the power cord. If the power cord is obviously damaged and/or gets hot during operation, replace the power cord completely.
 - DO NOT attempt to repair any power cord.
 - **To avoid risk of electric shock:** Always immediately wipe dry spilled liquids and condensation.
 - DO NOT place or immerse the appliance or power cord in water or any other liquid.
 - DO NOT spill or drip any liquids on the power cord, the connector - avoid spillage on the connector, or exterior of the appliance.
 - **DO NOT place the appliance or any part of it in an automatic dishwasher.**
- ### HIGH TEMPERATURES—RISK OF BURNS
- Do not overfill your Soup Maker.
 - Hot steam may escape jug when the lid is removed. Do not hold your hands, arms and/or face over the appliance when opening the lid to avoid scalds.
 - Steam could cause severe burns! Do not leave the appliance unattended, especially when the liquid within the appliance is hot!
 - Always leave your Soup Maker to cool down before cleaning.
 - **WARNING:** The heating element surface is subject to residual heat after use. Be careful.

Box Contents



Features

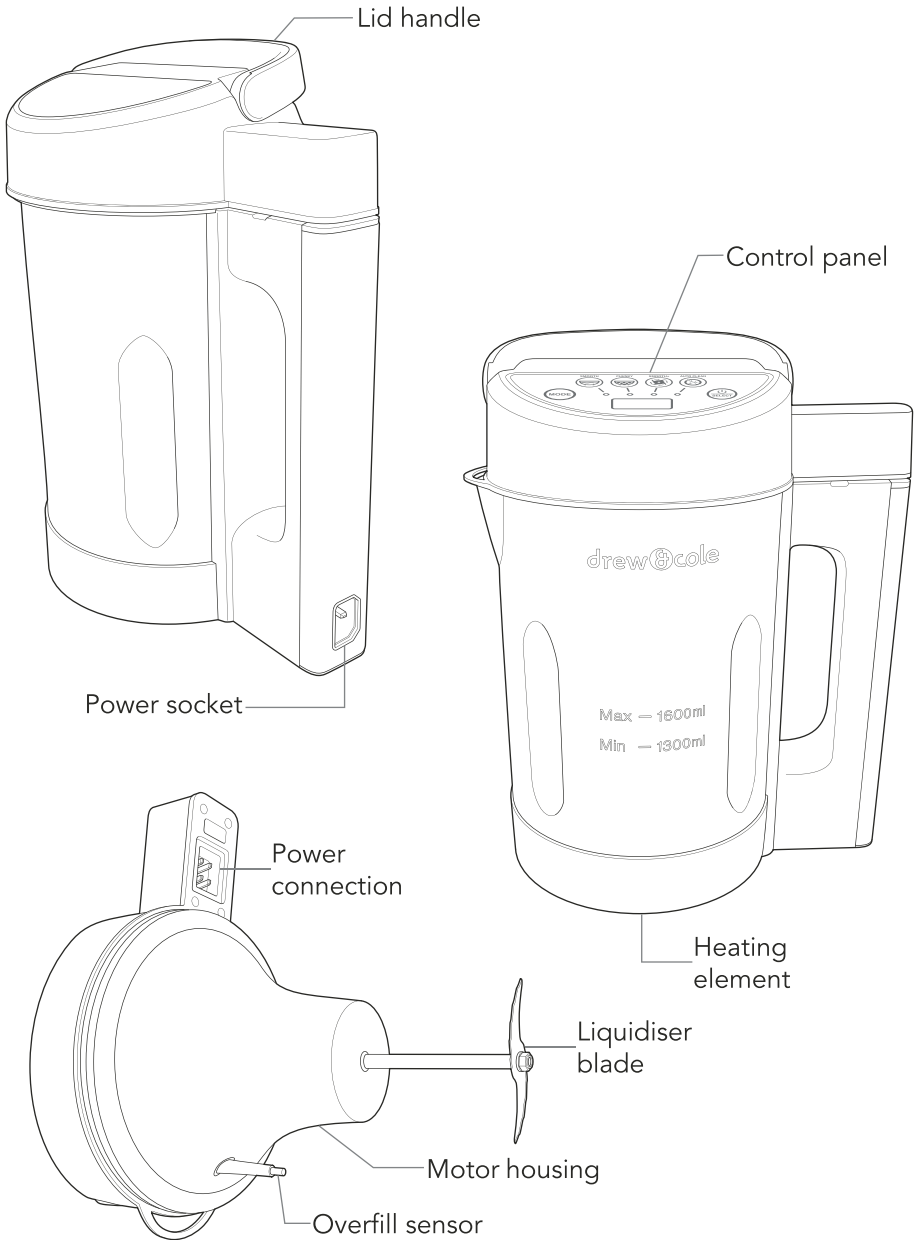

Control Panel

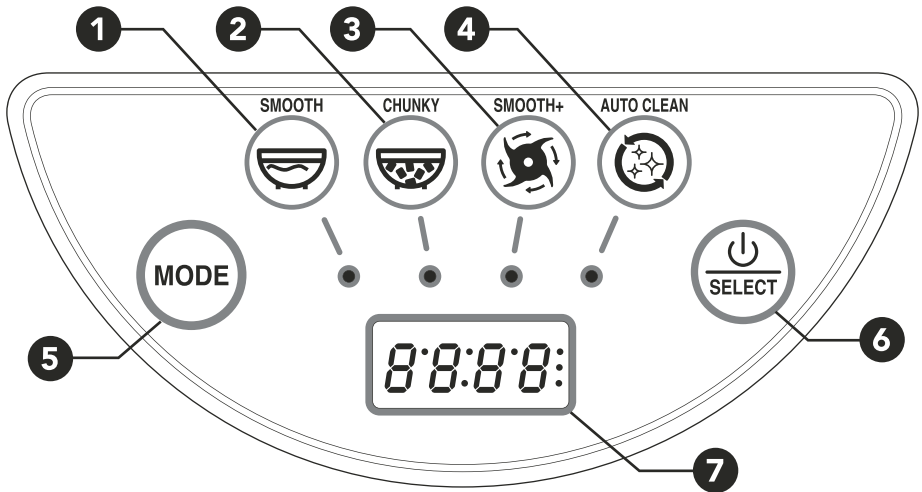

1 • SMOOTH: Use this function to make smooth soups.



2 • CHUNKY: Use this function to make chunky soups.



3 • SMOOTH+: Use this function to make smoothie and cold juice drinks and to also further blend your soup.



4 • AUTO CLEAN: Use this function to quickly clean your Soup Maker.

5 • MODE: Press this button to choose the function you want to use.

6 •  / SELECT: Press this button to select the function and start the cooking / function you have selected or turn your Soup Maker off.

7 • LED DISPLAY: This shows the cooking / function time remaining.

Before Using Your Soup Maker

IMPORTANT: Before using your Soup Maker you will need to clean it to remove any dirt accumulated whilst being transported.



Remove all of the packaging and dispose of in a safe manner.

WARNING:

Your Soup Maker is not dishwasher safe. You must never place your Soup Maker in a dishwasher.

Never immerse the jug or lid of your Soup Maker in water or any liquid.

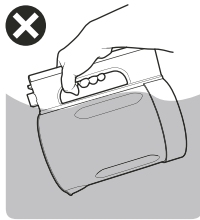

Remove the lid of your Soup Maker by lifting the handle upwards.

Lift the lid off your Soup Maker.

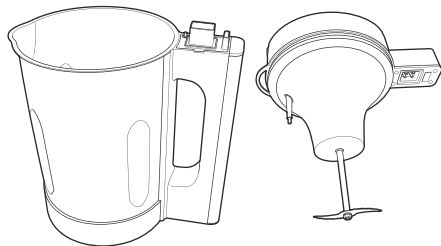

Clean the inside of the soup jug using a sponge dipped in warm water then wipe dry with a soft towel.

Clean the outsides, lid and blender with slightly damp cloth then wipe dry with a soft towel

CAUTION: Be careful when cleaning the blender blades as they are sharp and can cut.

Setting Up Your Soup Maker

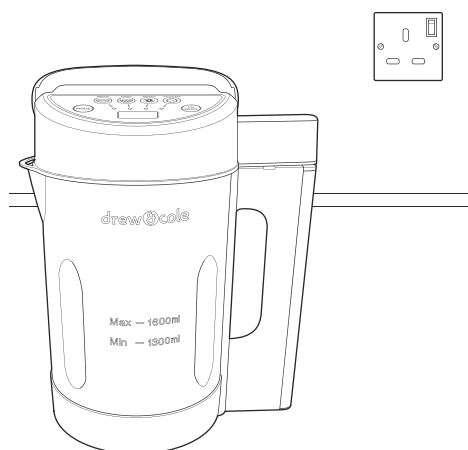

Place your Soup Maker on a firm level, heat resistant surface close to a wall socket.

Make sure that the Soup Maker is turned away from the socket - do not leave the Soup Maker steam outlet facing the socket as this could become a hazard.

Check that any fabric or other flammable items cannot come into contact with your Soup Maker when in use as it will become very hot.

IMPORTANT: Ensure that you have easy access to the socket even when using your Soup Maker.

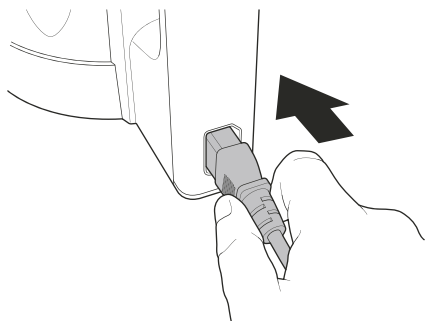

Slot the power cord into the power socket on the bottom of your Soup Maker's handle.

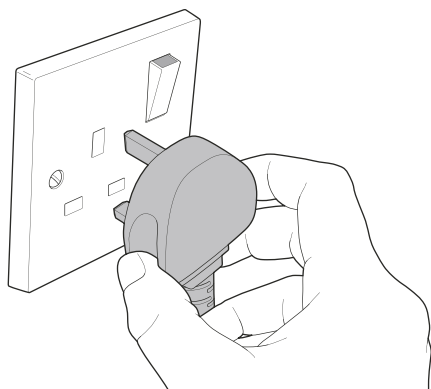

Slot the plug on the end of the power cord into a mains socket and turn the power on at the socket if required.

Preparation



Preparing meat

Always cook meat before adding it to your Soup Maker. Check that the meat is correctly cooked before adding it to your Soup Maker

You can use pre-cooked meat to make soups.

Never add frozen meat to your Soup Maker.

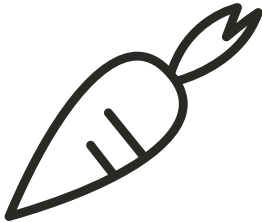

Preparing vegetables

Wash and peel (if required) all fresh vegetables ,then chop into bite size pieces and place in a bowl so you can easily add them to your Soup Maker. You can use frozen vegetables in your Soup Maker. It helps if the vegetables are left to defrost before adding to your Soup Maker or they can be soaked in hot water to aid with defrosting.

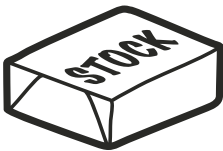

Preparing stock

If you are using powdered or cubed stock, it is best to dissolve them in warm water to ensure you do not have clumps of undissolved stock when using the CHUNKY soup function.

Making Soup

Your Soup Maker has two soup settings. You can choose between either **SMOOTH** or **CHUNKY** following the process shown below.

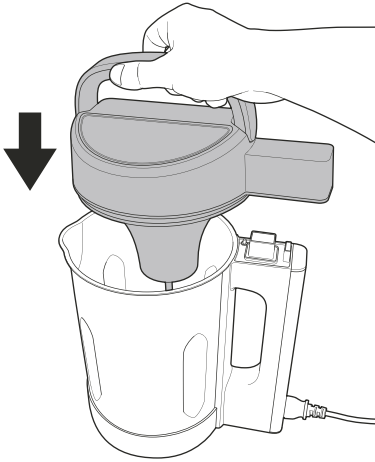

Place all of the ingredients and stock into your Soup Maker and slot the lid back onto the top of the soup jug.

NOTE: The lid can be removed during the cooking process (for up to 2 minutes at a time) to add ingredients that do not require the full cooking time or that were forgotten at the beginning. Take care when removing the lid as steam will be emitted.

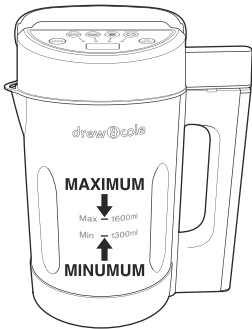

Adding your ingredients to your Soup Maker

Place the meat and vegetables into your Soup Maker and add the stock and stir. The level of stock **MUST** at least be above the **MINIMUM** mark on the side of your Soup Maker. If the level is below this mark add water until it is above the minimum mark. **NEVER** fill your Soup Maker above the **MAXIMUM** mark on the side of your Soup Maker.

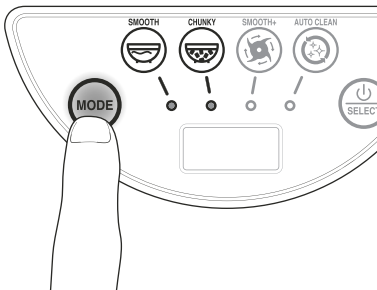

Press the **MODE** button on the top of your Soup Makers lid to select either the **SMOOTH** or **CHUNKY** function.

Making Soup (cont..)

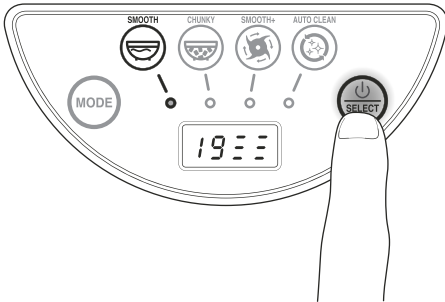

Once you have highlighted the function that you want press the **⏻ / SELECT** button to start the cooking process.

SMOOTH: Cooking time 19 minutes

CHUNKY: Cooking time 25 minutes

LED Display



The time required for the cooking process will be shown on the left side of the LED display, this will countdown as the soup is cooked.

HEATING



When you are cooking your soup the right side of your LED display will show the process the Soup Maker is doing.

HEATING: The red LED bars will scroll vertically up the display.

BLENDING



BLENDING: The red LED icons will switch from left to right showing that the Soup Maker is blending the contents.

RESTING



RESTING: The six red LED's will be permanently on showing the heating element is off and the contents are resting.

Serving Your Soup



Important: After cooking your soup, the walls of the soup kettle will be very hot and care should be taken when handling it. Use caution when removing the lid as steam will come out. Take care when pouring the soup as it will be very hot .

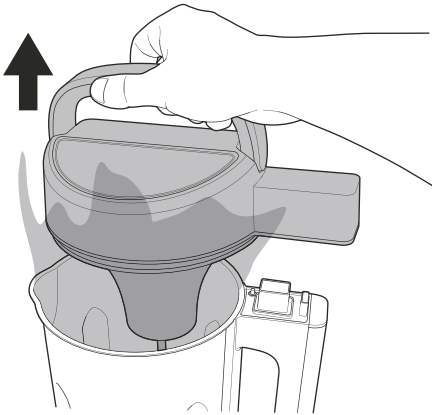

Remove the lid of the Soup Maker by lifting the handle upwards, then grip the handle of the soup jug and pull the lid upwards.

CAUTION: Be careful of the steam emitted when the lid is removed.

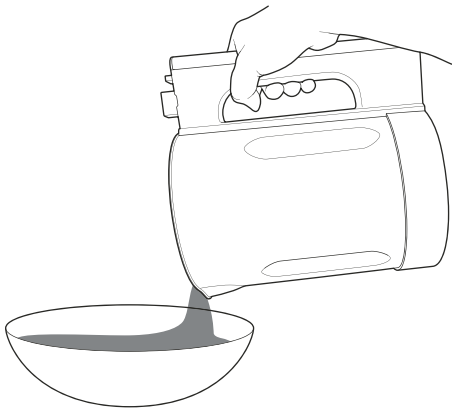

Pour the contents of the soup jug into bowls or a large heat proof serving container.

NOTE: If there is any soup left or you have made a batch of soup to be used later, the soup can either be kept in the fridge, or it can be frozen for later use - provided it is in an appropriate container. Do not put your Soup Maker in the fridge nor the freezer.

IMPORTANT: Never use the Soup Maker to reheat cold soup. Always reheat your soup in either a microwave or in a pan on a cooker.

Using the Smooth+ Function

The Smooth+ function is there to enable you to get the correct consistency for the food you are making. If you have used the Chunky function but would like to change the consistency of the soup, using this function will allow you change the consistency. As well as making soup you can also use your Soup Maker to make smoothies or milkshakes. Follow the instructions below for how to use the Smooth+ function to get your soup to the desired consistency.

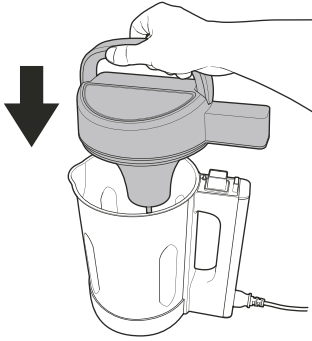

Place all of the ingredients into your Soup Maker and slot the lid back onto the top of the soup jug.

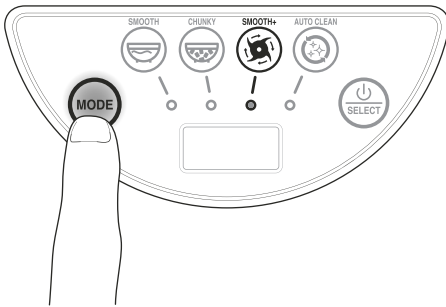

Press the **MODE** button on the top of your Soup Makers lid to select the SMOOTH+ function.

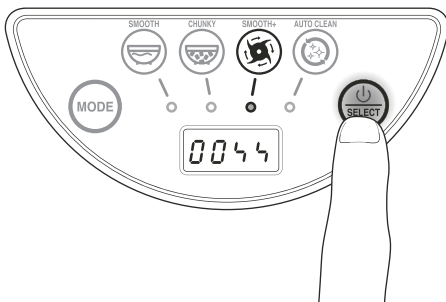

Once you have highlighted the function that you want, press and hold the ϕ / **SELECT** button to use the blender.

Release the ϕ / **SELECT** button to stop the blender. Continue to do this until the smoothie or soup is the correct consistency.

NOTE: The SMOOTH+ function does not heat the contents of the soup jug.

Using the Auto Clean Function

You can use the **AUTO CLEAN** function to quickly clean the inside of your Soup Maker. You may still need to wipe the inside of jug and the lid to remove all food particles.

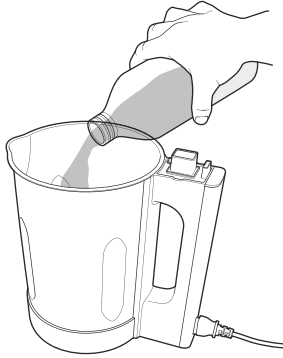

Fill the soup jug to the maximum level (1.6 L) with warm water.

IMPORTANT: Never place any abrasive cleaning agent in the water as this could damage your Soup Maker.

Place the lid back on your Soup Maker.

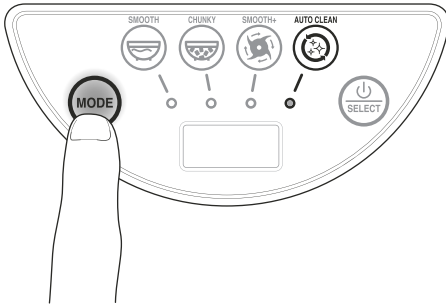

Press the **MODE** button on the top of your Soup Makers lid to select the **AUTO CLEAN** function.

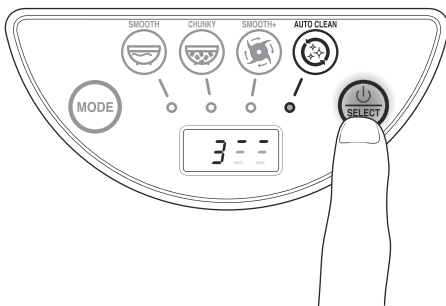

Once you have highlighted the **AUTO CLEAN** function press the **SELECT** button to start the cleaning process.

This will take 3 minutes.

Remove the lid and empty the water down a sink.

You can now wipe any other debris out of the jug and off the lid with a damp sponge then dry with a soft cloth.

Cleaning & Maintenance

- **Always ensure your Soup Maker is unplugged from the mains before performing any maintenance or cleaning tasks.**
- Wipe the outside of Soup Maker with a soft damp cloth then wipe with a dry cloth.
- Take care when cleaning the blender blades as they are sharp and can cut.
- **IMPORTANT: DO NOT use chemicals or abrasive cleaners to clean your Soup Maker.**
- After using your Soup Maker, always wipe the outside of the jug and lid with a damp cloth then wipe dry.
- **DO NOT IMMERSE YOUR SOUP MAKER IN WATER OR ANY OTHER LIQUID.**
- **IF YOUR SOUP MAKER IS NOT BEING USED, ALWAYS REMOVE THE PLUG FROM THE WALL SOCKET.**
- **WHEN YOUR SOUP MAKER IS NOT BEING USED, DO NOT FOLD THE POWER CORD.**

Troubleshooting

Issues	Cause	Solution
Your Soup Maker has no power.	Lid not fitted correctly or the power cord is not fitted correctly.	Refit the lid and check that the power cord is correctly fitted and the socket is switched on.
Your Soup Maker has stopped working during cooking	There is too much liquid or ingredients in your Soup Maker.	Ensure you do not overfill your Soup Maker.
The food has not been blended or is not completely cooked.	The ingredients have been cut into pieces that are too large.	Cut all your ingredients into approximately 2 cm cubes.

The product and its packaging have been manufactured from valuable materials that can be recycled. Recycling reduces the amount of refuse and helps to preserve the environment.

Dispose of the packaging at a recycling point that sorts materials by type. Make use of the local facilities provided for collecting paper, cardboard and light weight packaging.



Appliances marked with this symbol must not be disposed of along with normal household waste!

You are legally obliged to dispose of old appliances separately from household waste.

Information about collection points where old appliances can be disposed of free of charge is available from your local authorities.

Notes

drew & cole[®]

SWITCHED ON LIVING

Distributed by: High Street TV,
PO Box 724, Altrincham, WA15 5BJ
www.highstreettv.com

Please recycle our product and packaging where facilities exist. Check with your Local Authority or retailer for recycling in your country.

Model number: SM103B
V1-07/19

